

# Chcę samemu !

wychowanie, edukacja, pedagogika  
Montessori

Zestaw kart pracy:  
Dzień Maszynisty

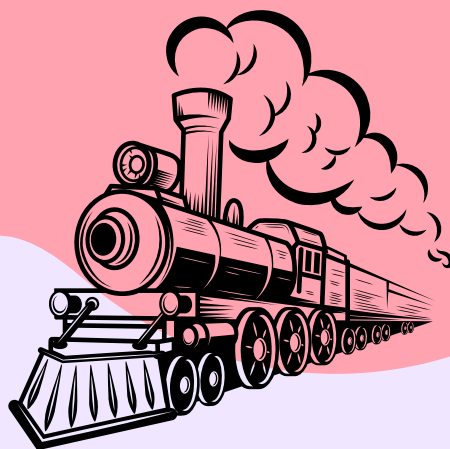

# Alfabet

Popraw po śladzie litery alfabetu.

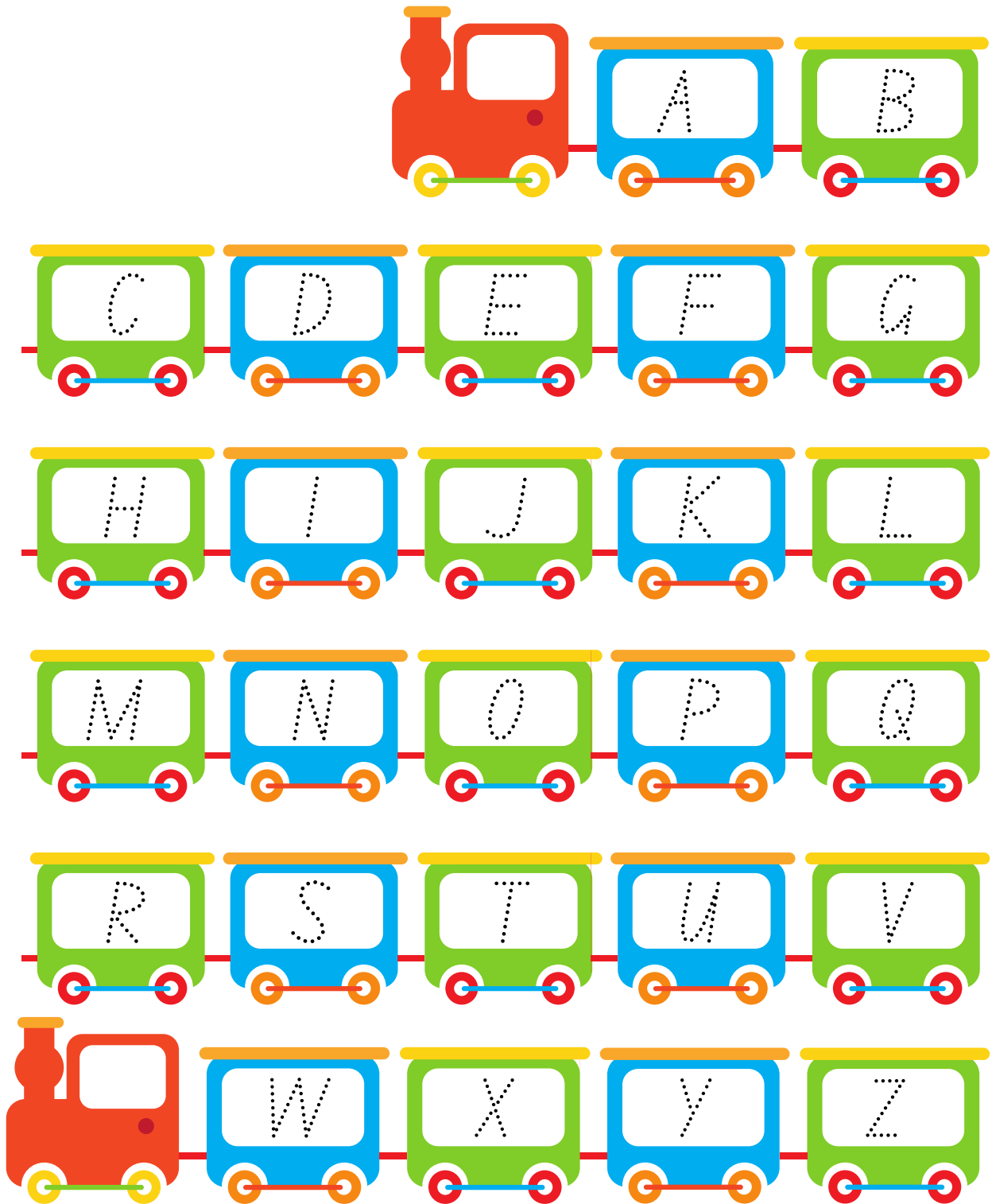

# Wycinanie

Wytnij po przerywanej kresce,  
zatrzymaj się, gdy dojdiesz do kropki.



# NUMEROWANIE

Wpisz w każdym rzędzie liczby, tak, aby były one po kolei.

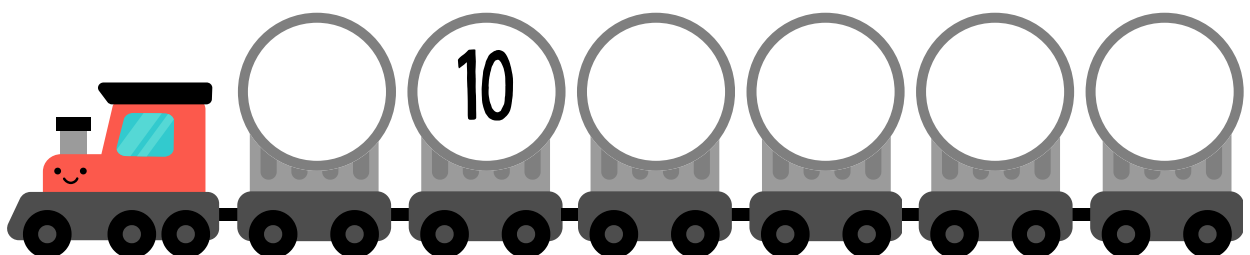
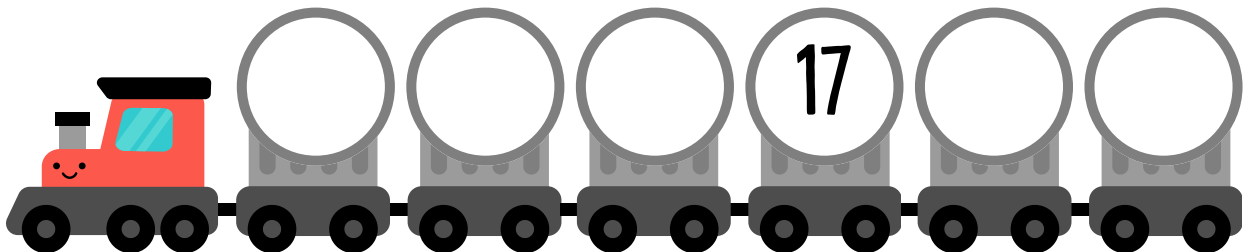
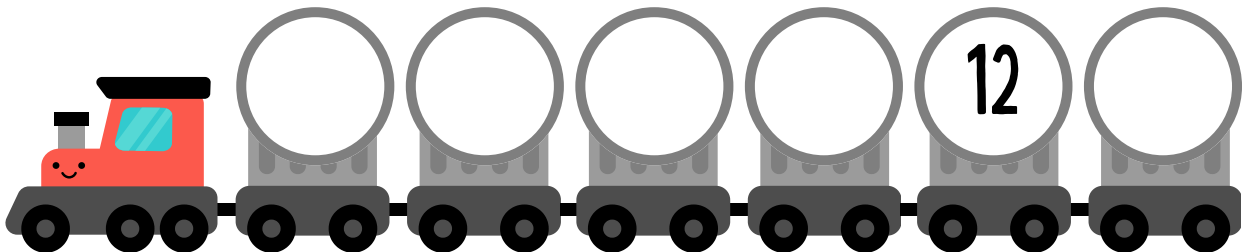
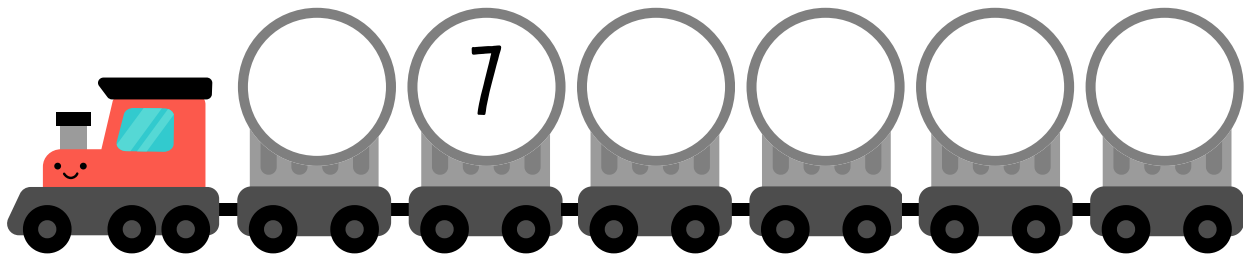
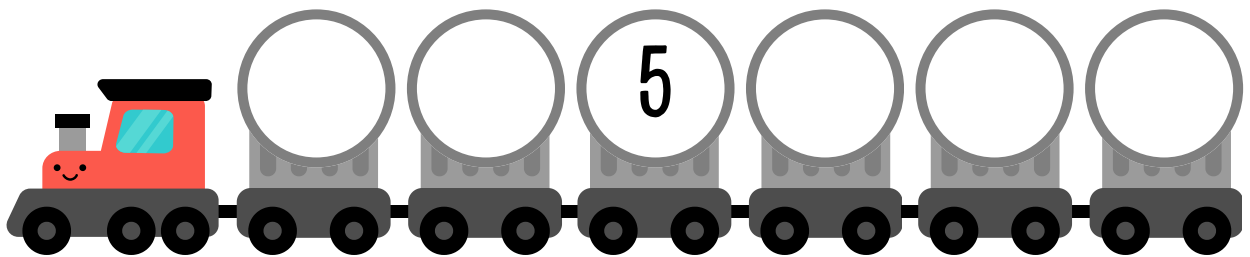

# POCIĄG

Połącz kropki w odpowiedniej kolejności, tak, aby powstał pociąg. Pokoloruj go.

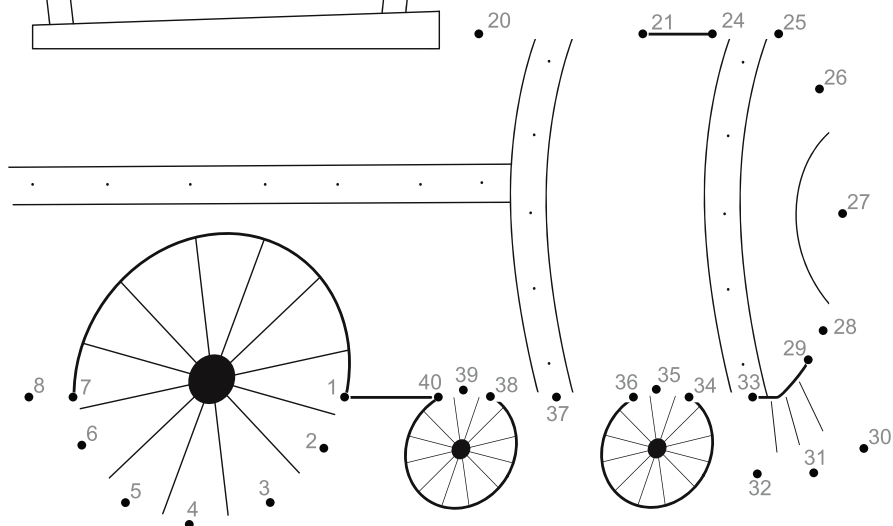
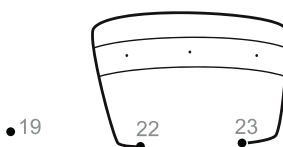
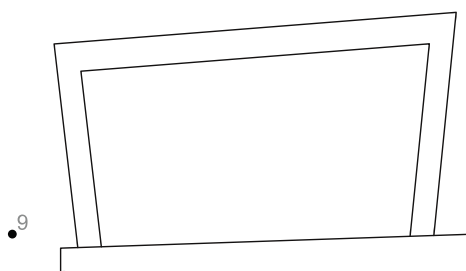
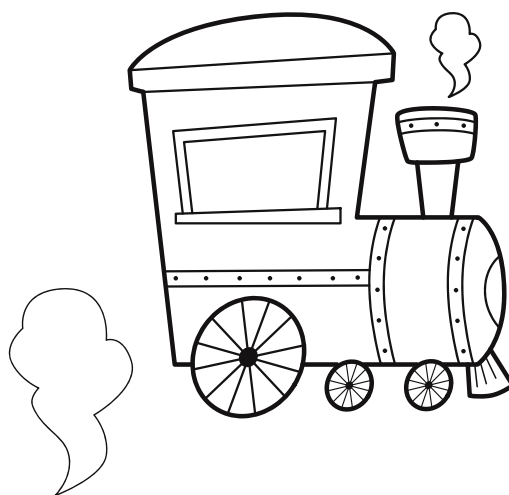
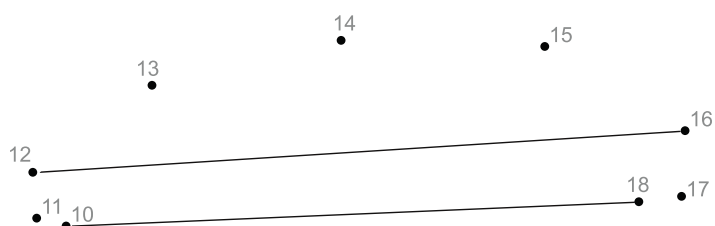

# Liczbowe łamigłówki

Przyjrzyj się zestawom liczb w każdym pociągu. Ułóż je w kolejności rosnącej na pustych polach obok każdego z nich.

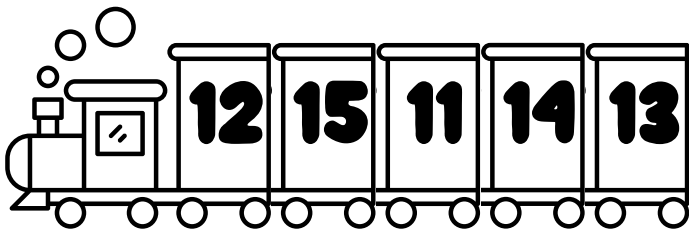
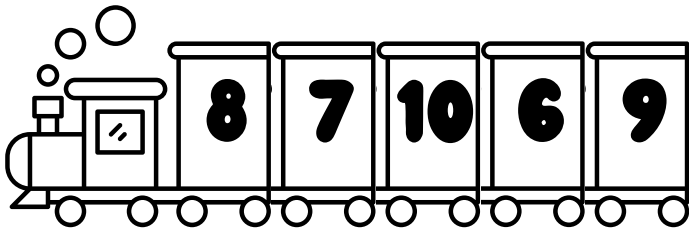
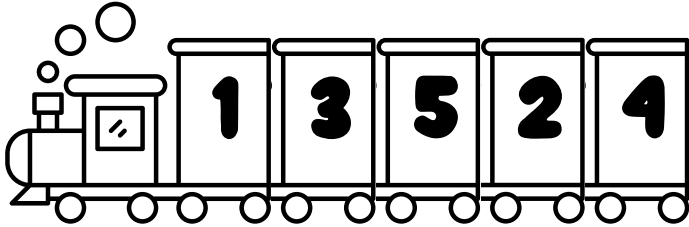

# Alfabetyczne słowa

Odczytaj słowa w wagonach, przepisz je alfabetycznie .

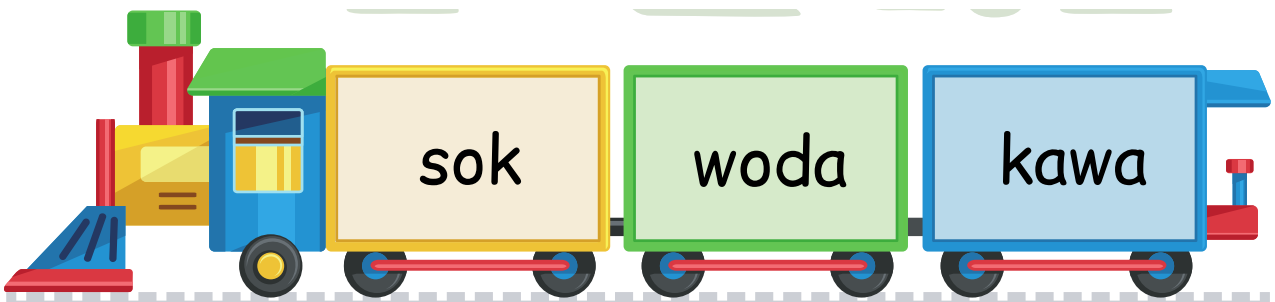
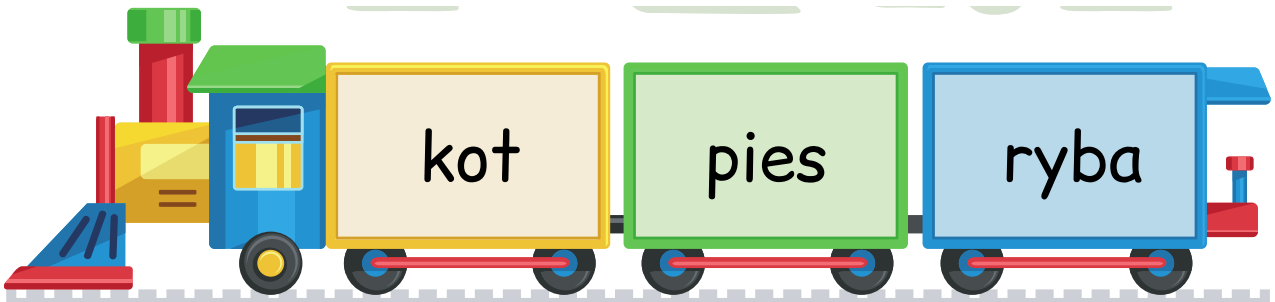

# Grupowanie

Wytnij obrazki i dopasuj do odpowiedniej kolumny.

Pociąg

Samolot

